

## DESCRIPTION

AMCOM's AM008030WM-BM/FM-R is an ultra broadband GaAs MMIC power amplifier. It has 23dB gain, and >28dBm output power over the 0.05 to 10GHz band. This MMIC is in a ceramic package with both RF and DC leads at the bottom level of the package to facilitate low-cost SMT assembly to the PC board. AM008030WM-FM-R is AM008030WM-BM-R assembled on a gold plated copper flange carrier for screwing on to a metal heat sink. Both parts are RoHS compliant.

## FEATURES

- Ultra wide bandwidth from 50MHz to 10GHz
- High output power, P1dB = 30.5dBm
- High gain, 18dB
- Input /Output matched to 50 Ohms

## APPLICATIONS

- Software Radio
- Instrumentation
- Gain block

## TYPICAL PERFORMANCE \* (Bias Conditions\*\*: $V_{dd} = +12V$ , $I_{dq} = 400mA$ )

Parameters	Minimum	Typical **	Maximum
Frequency	0.1 – 8GHz	0.05 – 10GHz	
Small Signal Gain	14dB	18dB	22dB
Gain Ripple		± 3dB	± 4.0dB
P1dB @ 2GHz	29dBm	30dBm	
P1dB from 0.1 to 8GHz		> 27dBm	
Psat @ 2GHz	30dBm	31dBm	
Psat from 0.1 to 8.0GHz		> 28dBm	
IP3 @ 1GHz		48dBm	
Input Return Loss	9dB	15dB	
Output Return Loss	7dB	10dB	
Thermal Resistance		4.5 °C/W	

\* Specifications subject to change without notice.

\*\* Gate biases corresponding to above currents are  $V_{gs1} = -0.7V$ ,  $I_{gs1} < 0.5mA$ ,  $V_{gs2} = -0.7V$ ,  $I_{gs2} < 1mA$  and may vary from lot to lot. Gate currents could reach above limits only near power saturation

**ABSOLUTE MAXIMUM RATING**

Parameters	Symbol	Rating
Drain source voltage	$V_{dd}$	13V
Gate source voltage	$V_{gs1}$ & $V_{gs2}$	-3V
Drain source current	$I_{dq1}$	0.2A
Drain source current	$I_{dq2}$	0.40A
Continuous dissipation at 25°C	$P_t$	7.8W
Channel temperature	$T_{ch}$	175°C
Operating temperature	$T_{op}$	-55°C to +85°C
Storage temperature	$T_{sto}$	-55°C to +135°C

**SMALL SIGNAL DATA\***

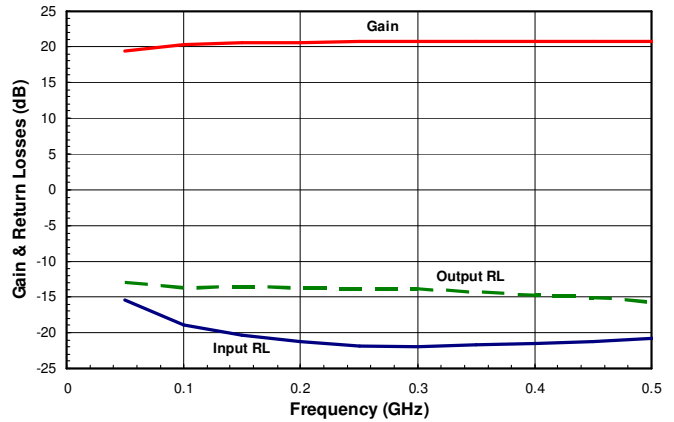
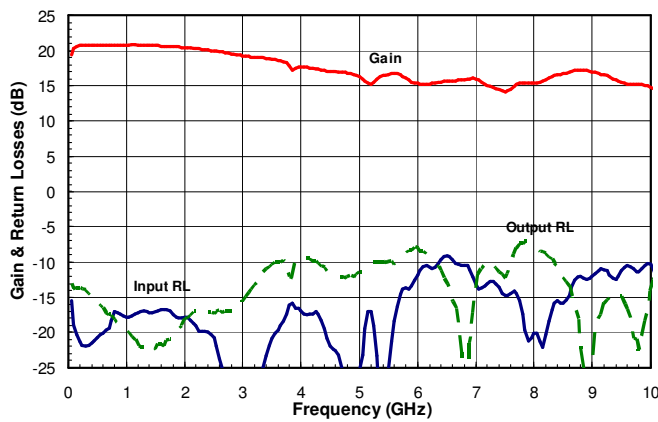

\* S-Parameters measured using bias tee at the output. MMIC could be operated at lower than  $V_{dd}=+12V$  with almost same small signal parameters.

POWER DATA\*

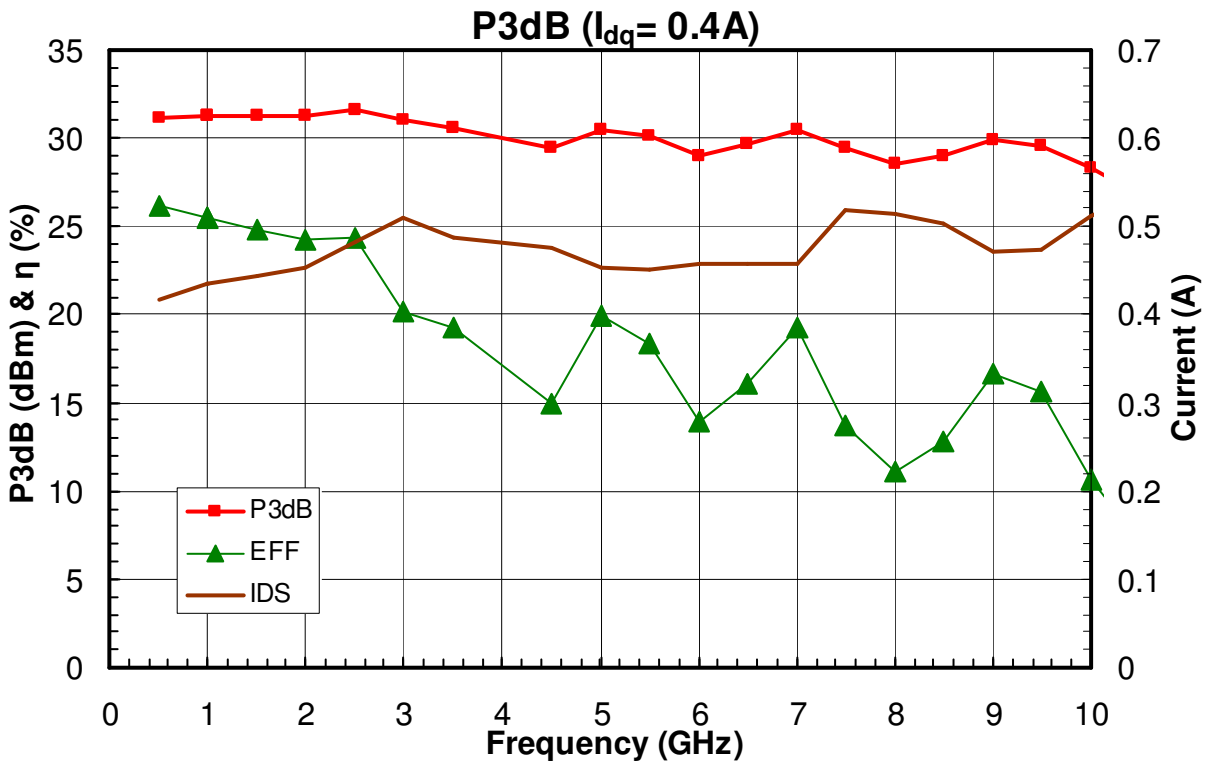
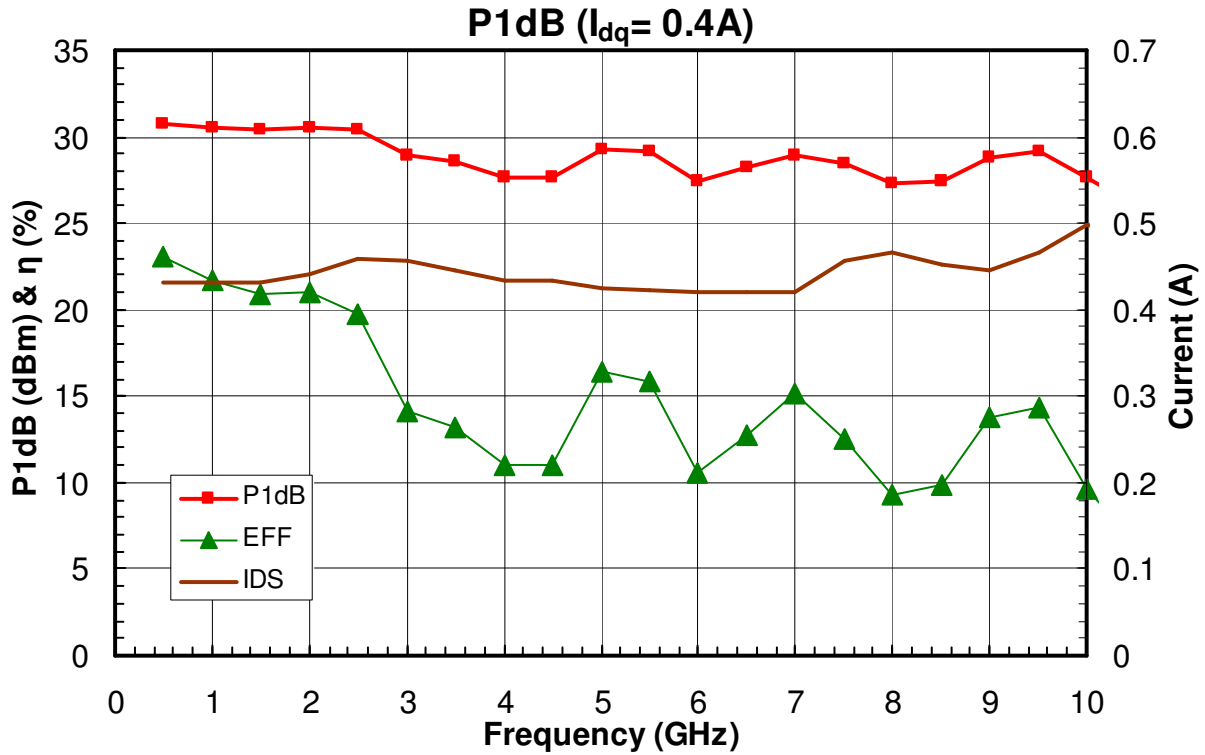

\* Power measured using bias tee at the output. MMIC could be operated at lower than  $V_{dd} = +12V$  with reduced power output.

**PACKAGE OUTLINE (BM)**

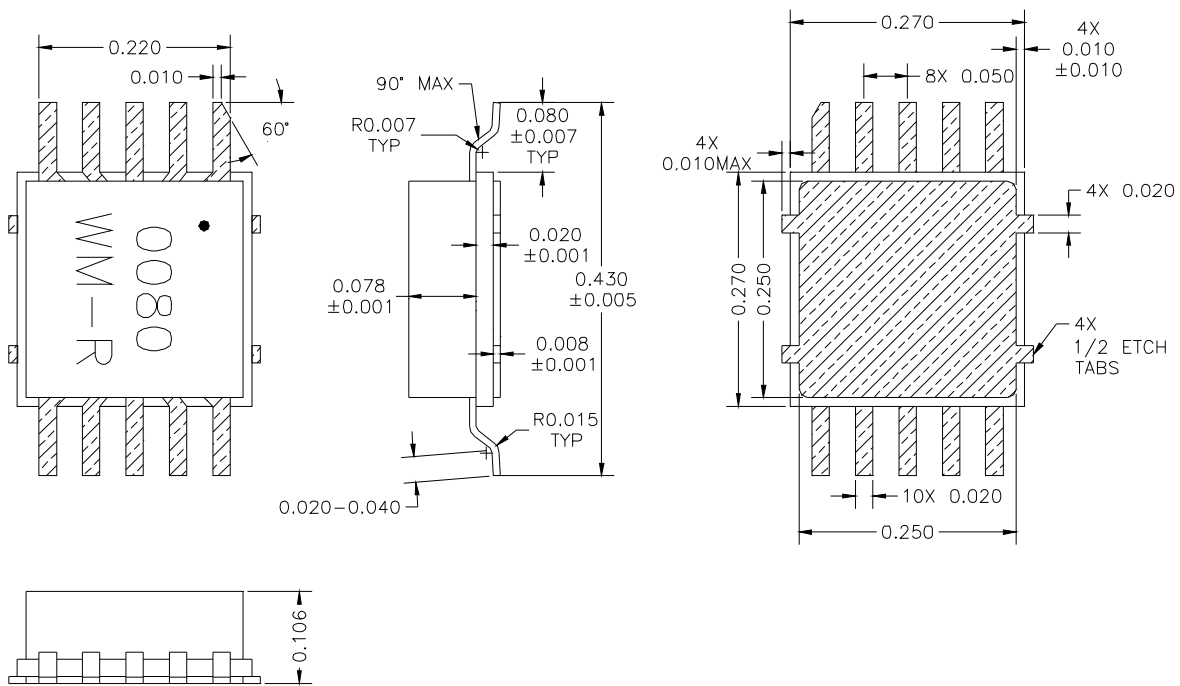

- Gate biases are for reference only and may vary from lot to lot

**Pin Layout**

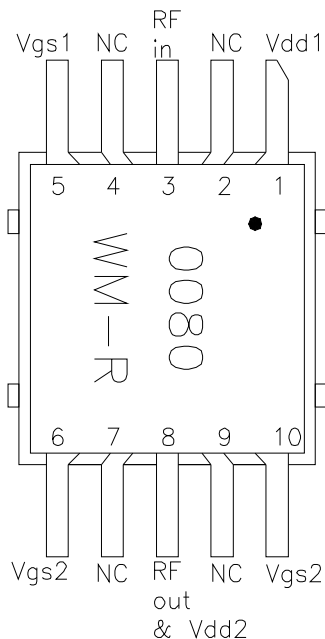

Pin No.	Function	Bias
1	Vdd1	+12V
2	NC	
3	RF in	
4	NC	
5	Vgs1	-0.7V
6	Vgs2	-0.7V
7	NC	
8	RF out & Vdd2	+12V
9	NC	
10	Vgs2	

PACKAGE OUTLINE (FM)

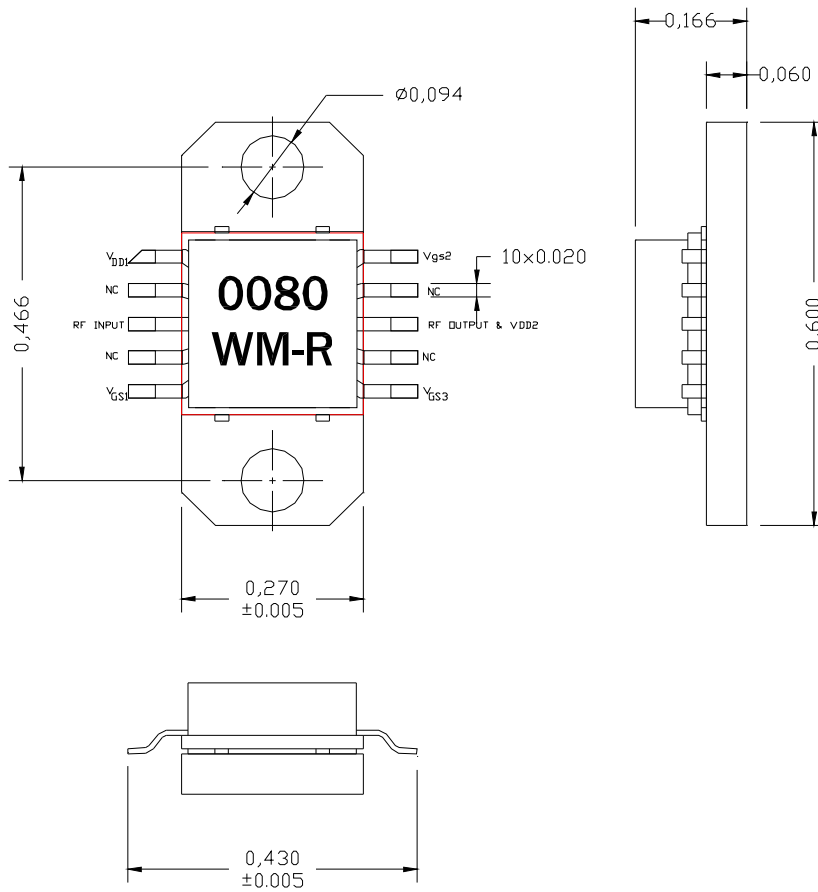

Pin Layout

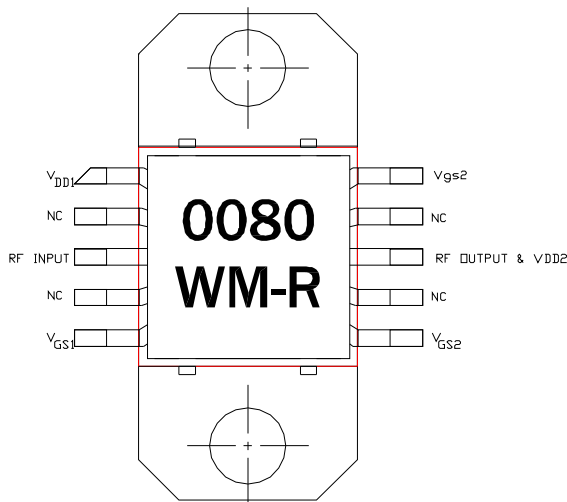

Pin No.	Function	Bias
1	Vdd1	+12V
2	NC	
3	RF in	
4	NC	
5	Vgs1	-0.7V
6	Vgs2	-0.7V
7	NC	
8	RF out & Vdd2	+12V
9	NC	
10	Vgs2	

TEST CIRCUIT for BM Package

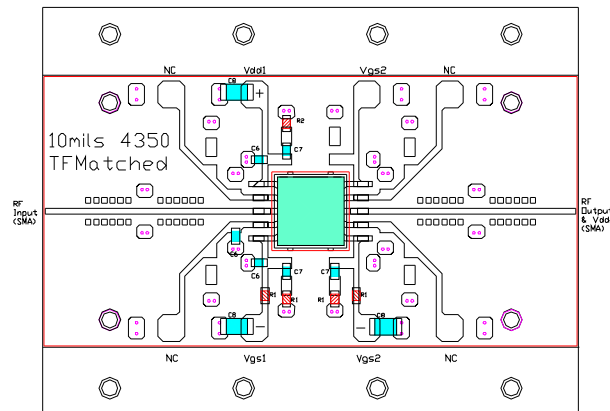

- Notes:
- 1- 10mils Rogers 4350 Material epoxied
  - 2- Ckt is for matched MMICs
  - 3- C6=20pF, C7=1000pF, C8=10uF  
R1=50 Ohms, R2=10 Ohms, R3=5 Ohms
  - 4- All Caps & Resistors are 0603 size except for C8: 1206 size

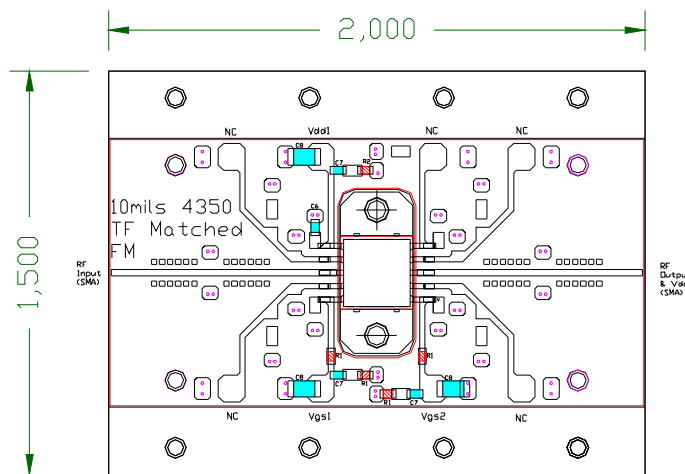

- Notes:
- 1- 10mils Rogers 4350 Material epoxied
  - 2- Ckt is for matched MMICs
  - 3- C6=20pF, C7=1000pF, C8=10uF  
R1=50 Ohms, R2=10 Ohms, R3=5 Ohms
  - 4- All Caps & Resistors are 0603 size except for C8: 1206 size

Important Notes:

- 1- The +12V Bias to the output port could be provided via a bias tee or suitable chokes to be soldered on the board. Inductance of choke should be large enough to have high impedance at lowest frequency of operation (300nH is adequate).
- 2- Recommended current biases are 130mA and 270mA for the first stage and second stage respectively. Gate biases of -0.7V are for reference only.  $V_{gs1}$  &  $V_{gs2}$  could be adjusted to vary the currents going thru the first stage ( $V_{dd1}$  pin) and the second stage ( $V_{dd2}$  pin) respectively.
- 3- Do not apply  $V_{dd1}$  &  $V_{dd2}$  without proper negative voltages on  $V_{gs1}$  &  $V_{gs2}$ .
- 4- The currents flowing out of the  $V_{gs1}$  &  $V_{gs2}$  pins are less than 0.5mA & 1mA respectively at  $P_{1dB}$ .
- 5- External 1  $\mu$ F dipped tantalum capacitor should be attached to Vd and Vg to decouple external bias leads.