

DESCRIPTION

AMCOM's AM153540WM-BM-R and AM153540WM-FM-R are part of the GaAs HiFET MMIC power amplifier series. It is a 2-stage GaAs HIFET PHEMT MMIC power amplifier. It is fully matched to 50-ohm at both input and output, covering 1.5 to 3.5GHz. The MMIC has 18dB gain and 39dBm output power at 14V. The BM package RF and DC leads are coplanar with the bottom level of the package, which serves as ground, to facilitate low-cost SMT assembly to the PC board. Because of high DC power dissipation, we strongly recommend to mount this device directly on a metal heat sink. The FM package is the BM package mounted on a copper flange carrier. There are two screw holes on the flange to facilitate screwing on to a metal heat sink. Both MMICs are RoHS compliant.

FEATURES

- Frequency applications from 1.5 to 3.5GHz
- High output power, P1dB = 39dBm
- Gain = 18dB
- Input & Output matched from 1.5GHz to 3.5GHz

APPLICATIONS

- PCS Base Station
- GPS Applications
- MMDS
- WLAN Repeaters
- 10V – 16V Applications

TYPICAL PERFORMANCE ON A TEST BOARD*

Performance at $V_{dd} = +14V$, $V_{gs} = -0.95V^{**}$, $I_{dq} = 1300mA$, $T_a = 25^{\circ}C$

Parameters	Minimum	Typical	Maximum
Frequency	2.0 – 3.0GHz	1.5 – 3.5GHz	-
Small Signal Gain	15dB	18dB	25dB
Gain Ripple	-	± 3.0dB	± 4.0dB
P1dB	37.5dBm	39.0dBm	-
Psat	38dBm	39.5dBm	-
IP3	-	48dBm	-
Efficiency @ P1dB	-	35%	
Input Return Loss	13dB	20dB	
Output Return Loss	6dB	10dB	
Thermal Resistance		5°C/W	

*Specifications subject to change without notice.

** V_{gs} may vary from lot to lot

ABSOLUTE MAXIMUM RATING

Parameter	Symbol	Rating
Drain source voltage	V_{dd}	16V
Gate source voltage	V_{gs}	-5V
Drain source current	I_{dd}	2.0A
Continuous dissipation at room temperature	P_t	32W
Channel temperature	T_{ch}	175°C
Storage temperature	T_{sto}	-55°C to +135°C

SMALL SIGNAL DATA ($V_{dd} = +14V$, $V_{gs} = -0.95V^{**}$, $I_{dq} = 1300mA$, $T_a = 25^{\circ}C$)

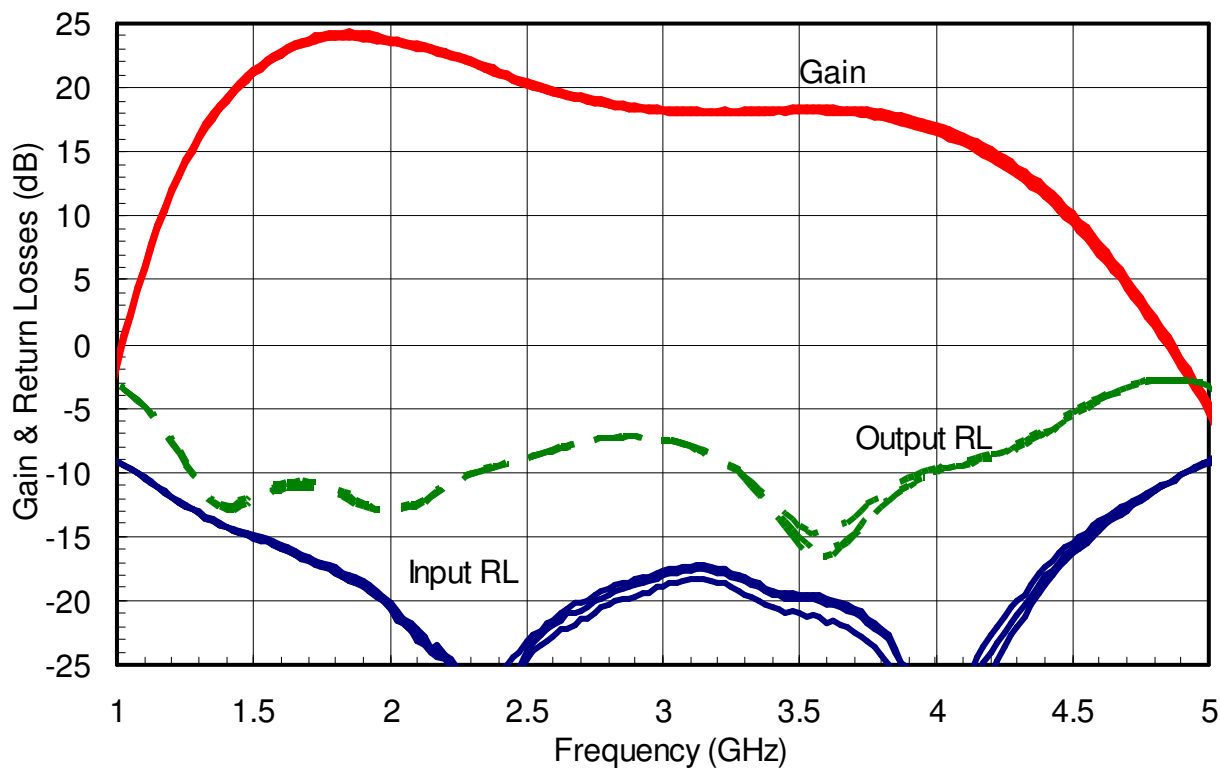

** V_{gs} may vary from lot to lot

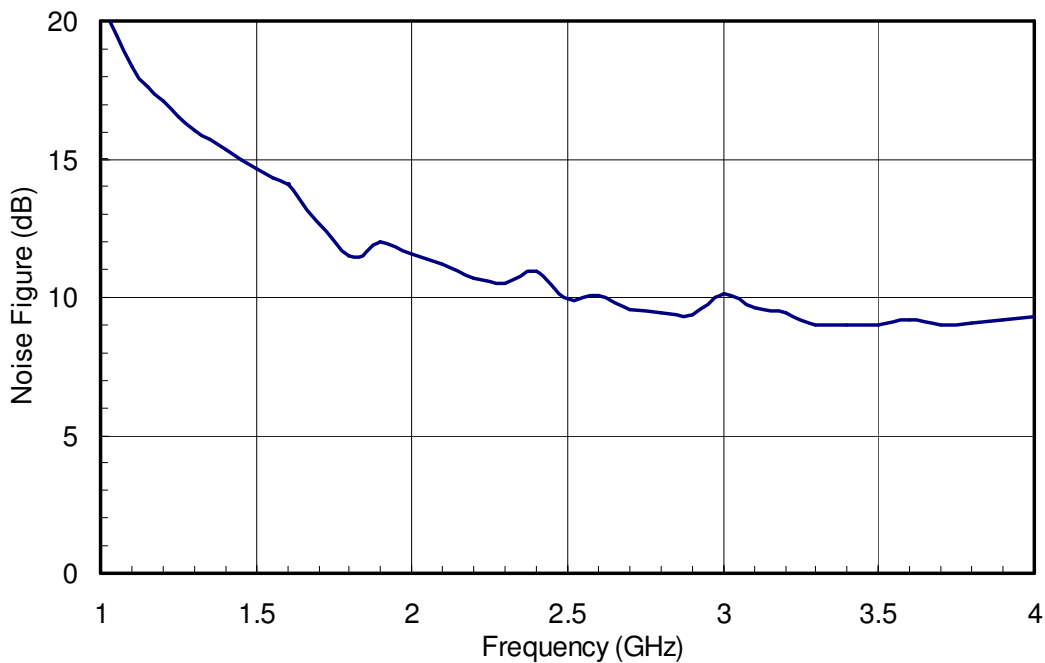

POWER DATA

A) Output Power & Efficiency

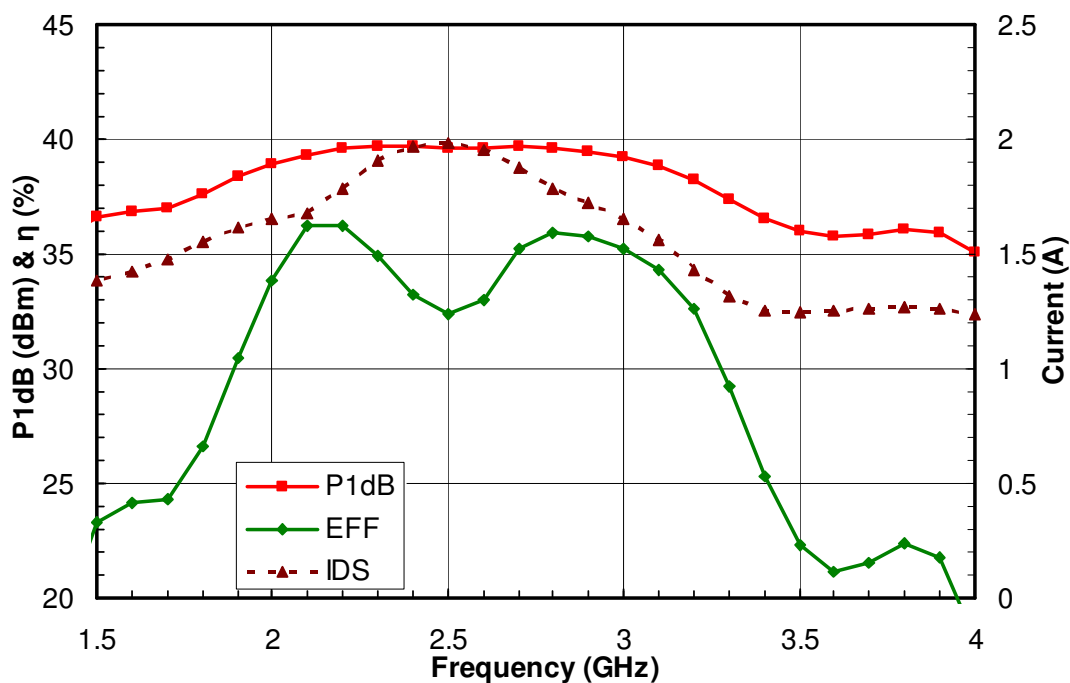

$V_{dd} = +14V$, $V_{gs} = -0.95V^{**}$, $I_{dq} = 1300mA$, $T_a = 25^\circ C$

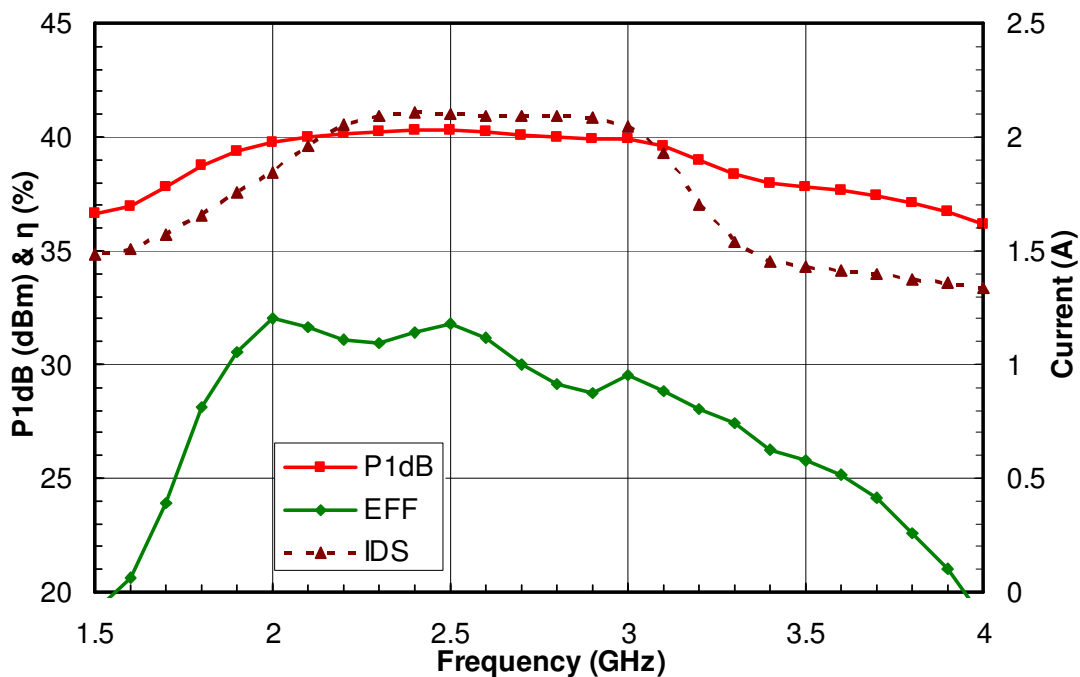

$V_{dd} = +16V$, $V_{gs} = -0.95V^{**}$, $I_{dq} = 1300mA$, $T_a = 25^\circ C$

** V_{gs} may vary from lot to lot

B) Harmonics at P_{1dB} ($V_{dd} = +14V$, $V_{gs} = -0.95V^{**}$, $I_{dq} = 1300mA$, $T_a = 25^\circ C$)

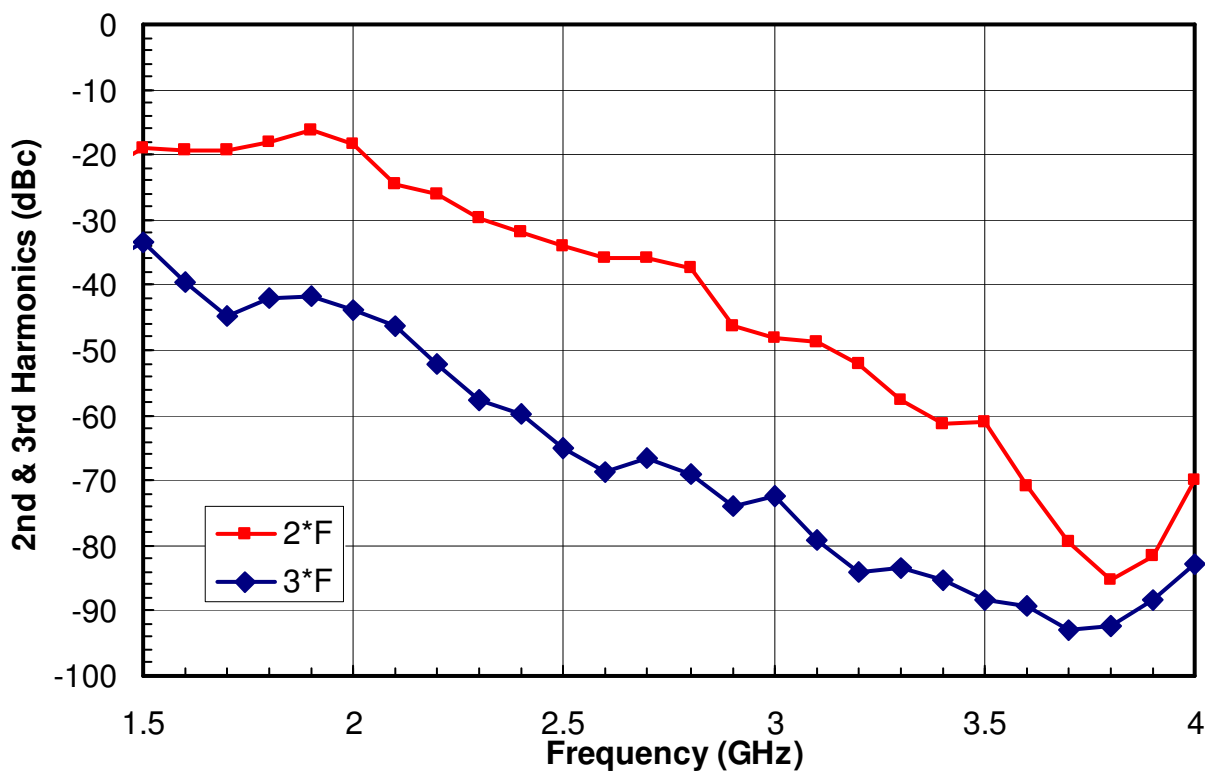

C) IMD3 & IMD5 at $P_{out} = 25dBm$ ($V_{dd} = +14V$, $V_{gs} = -0.95V^{**}$, $I_{dq} = 1300mA$, $T_a = 25^\circ C$)

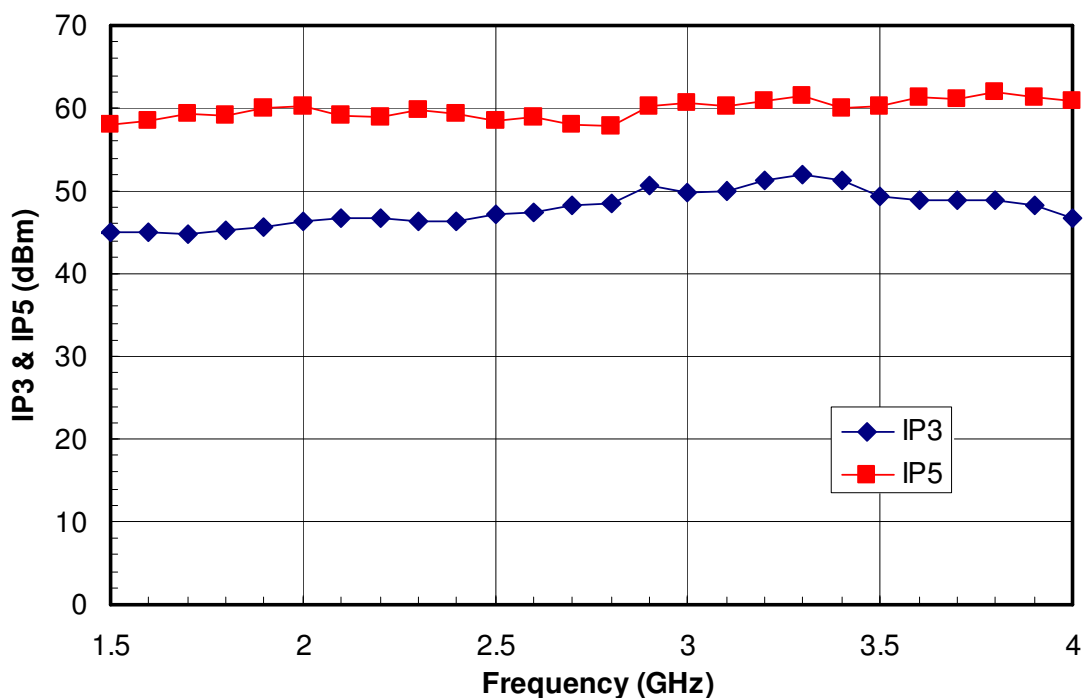

PACKAGE OUTLINE (BM)

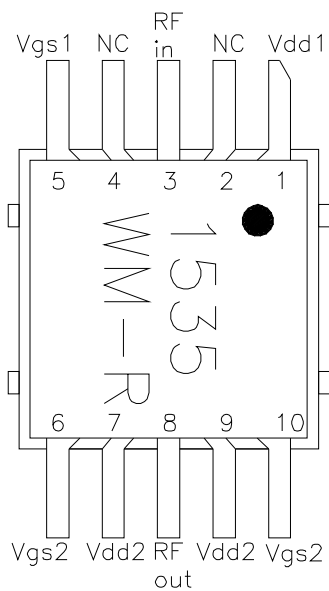
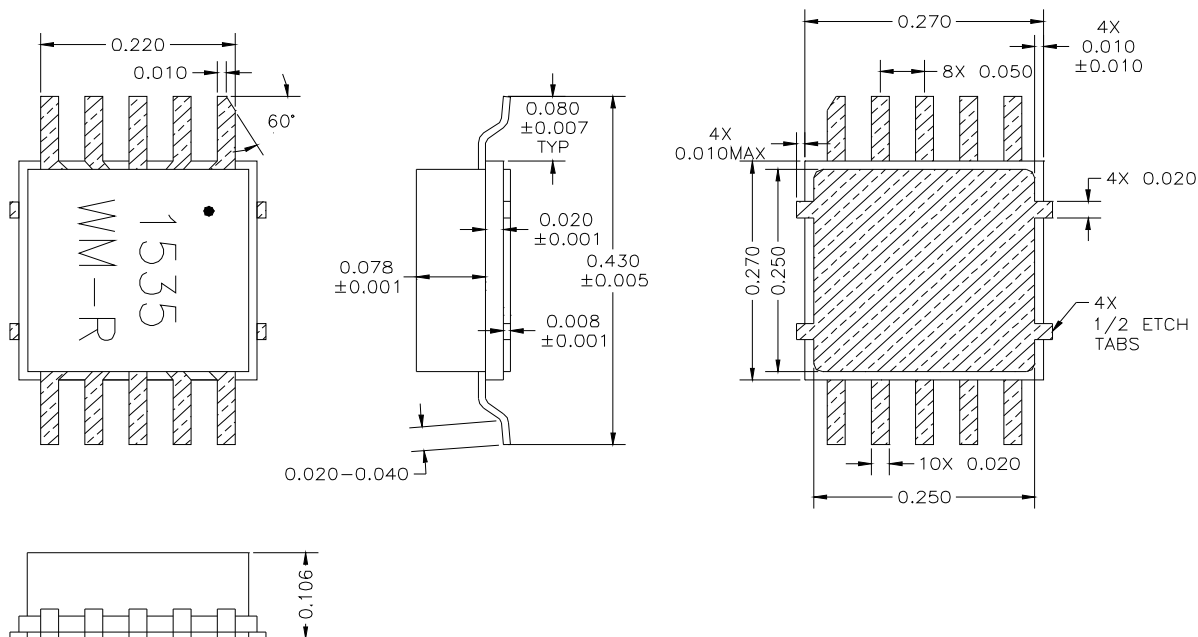

Pin No.	Function	Bias**
1	Vdd1	+14V
2	NC	
3	RF in	
4	NC	
5	Vgs1	-0.95V
6	Vgs2	-0.95V
7	Vdd2	+14V
8	RF out	
9	Vdd2	+14V
10	Vgs2	-0.95V

Pin Layout

** V_{gs1} & V_{gs2} may vary from lot to lot

PACKAGE OUTLINE (FM)

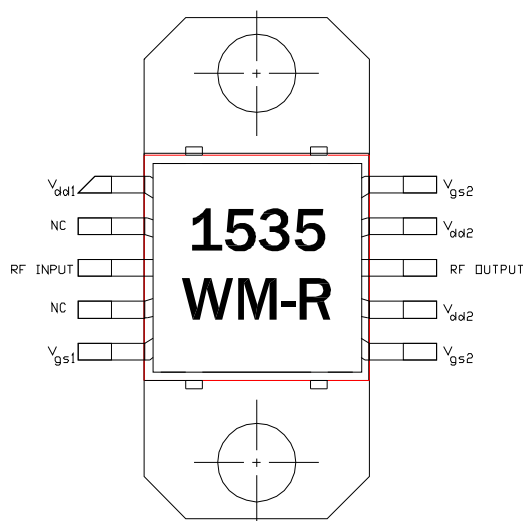
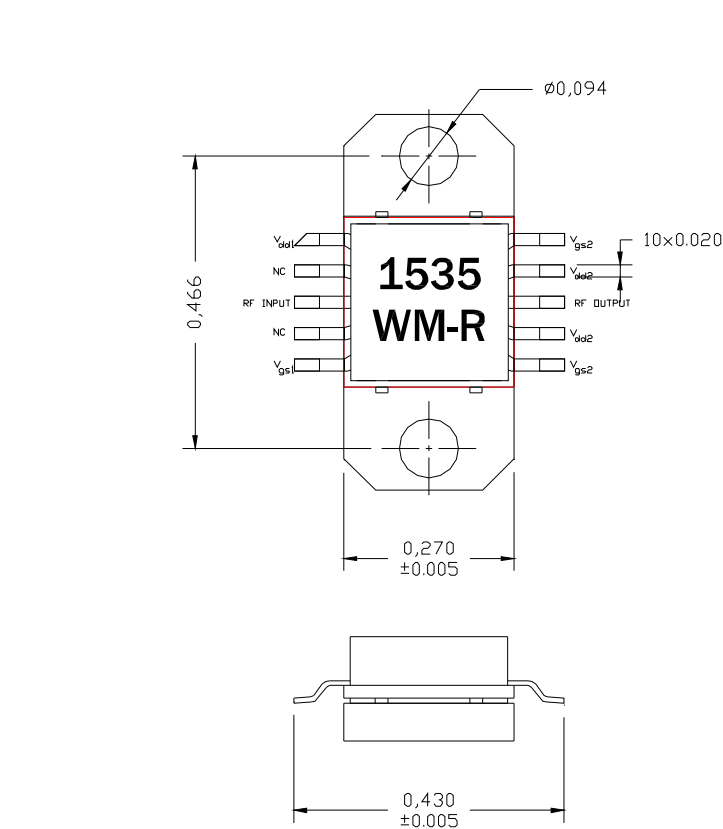

Pin No.	Function	Bias**
1	Vdd1	+14V
2	NC	
3	RF in	
4	NC	
5	Vgs1	-0.95V
6	Vgs2	-0.95V
7	Vdd2	+14V
8	RF out	
9	Vdd2	+14V
10	Vgs2	-0.95V

Pin Layout

** V_{gs1} & V_{gs2} may vary from lot to lot

TEST CIRCUIT for BM package

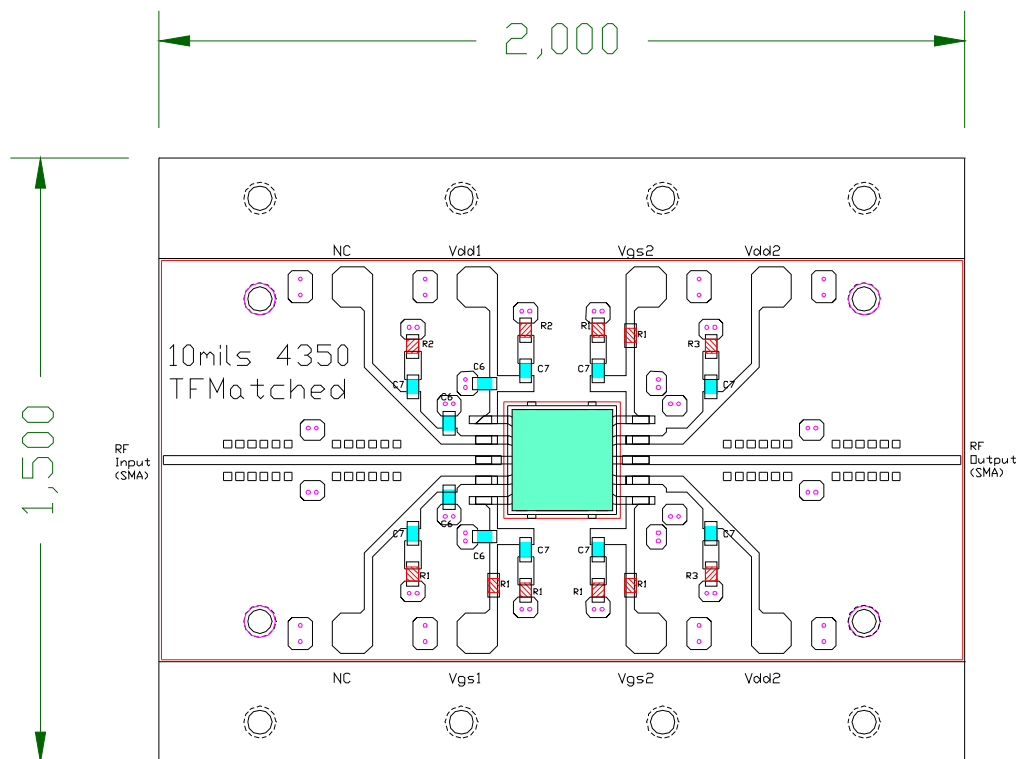

Notes:

- 1- 10mils Rogers 4350 Material epoxied
- 2- Ckt is for matched MMICs
- 3- C6=20pF, C7=1000pF,
R1=50ohms, R2=10ohms, R3=5ohms
- 4- All Caps & Resistors are 0603 size

Important Notes:

- 1- The MMIC should have a good heat sink to avoid overheating. MMIC should be attached on direct ground for lowest junction temperature.
- 2- If surface mount is used, use PC board thickness < 10mils and ensure vias are filled with solder or metal to lower PCB heat resistance. For surface mount the MMC should be de-rated to a maximum +10V bias.
- 3- Recommended current biases are 300mA & 1000mA for the first and second stages respectively.
- 4- Do not apply V_{dd1} & V_{dd2} without proper negative voltages on V_{gs1} & V_{gs2} .
- 5- The currents flowing out of the V_{gs1} & V_{gs2} pins are less than 2mA & 12mA at P_{1dB} .

TEST CIRCUIT for FM package

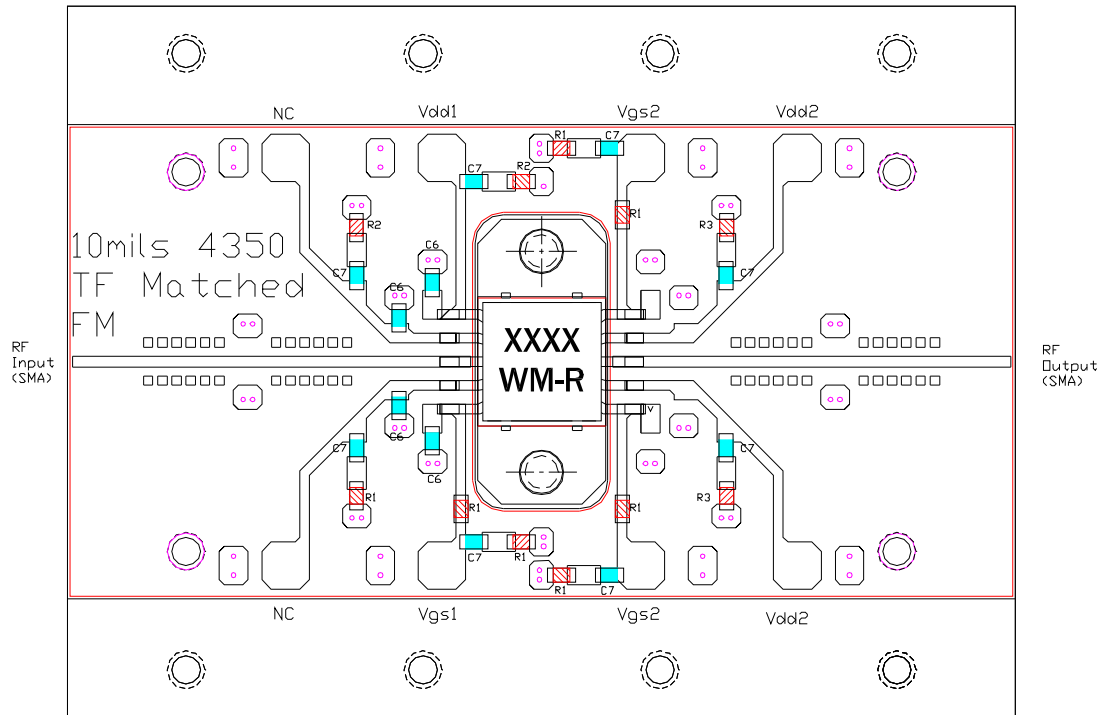

- Notes:
- 1- 10mils Rogers 4350 Material epoxied
 - 2- Ckt is for matched MMICs
 - 3- C6=20pF, C7=1000pF,
R1=50ohms, R2=10ohms, R3=5ohms
 - 4- All Caps & Resistors are 0603 size